



# FRUIT VINEGAR

## Introduction

A wide range of seasonal fruits grow in Northern Peru but their seasonality causes problems for farmers through low prices and post-harvest losses. One option to better make use of this fruit is to produce a good quality competitively priced fruit vinegar for the local market. Only a small production unit is required costing about \$US 3600 for equipment and materials. A working capital of \$750 is needed to produce 350 litres of vinegar; equivalent to 778 bottles of 450 ml.

The technology involved is quite simple. An industrial liquidiser is used to prepare the fruit must that is fermented and plastic containers are used for the two fermentations required (alcoholic and acetic). Bottling is done by hand. The plant's maximum capacity is 2,000 bottles (450 ml) per month. However all costs can be covered when producing just over 600 bottles per month.

## Raw materials and equipment

The following items are needed to process 50kg of ripe banana and make 350 litres of white vinegar.

### Raw materials

In this example we will use ripe bananas but a whole variety of fruits such as apples, pineapples and peaches etc can be used when they are cheap.

### Water

Boiled water must be used. During the process we used boiled that has been allowed to cool to dilute the liquidised fruit pulp. Each fruit is slightly different and so must be treated differently.

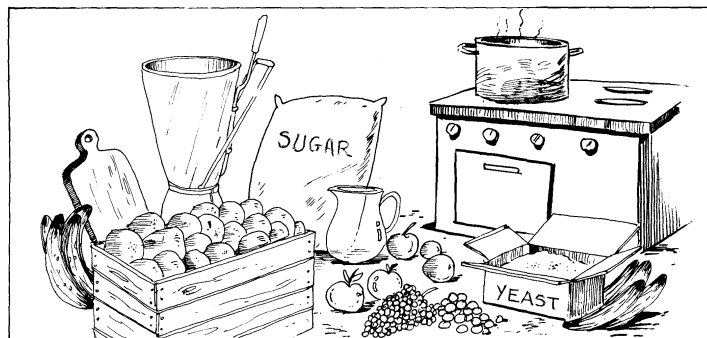

### Yeast

Yeast is used for the alcoholic fermentation of the must. We use ordinary bread yeast to do this (1 gr. of yeast x 1 litre of prepared must)

Vinegar starter - acetic acid producing bacteria

Vinegar that has not been pasteurised (heated to make it sterile) has an acetic acidity between 5% and 8% and contains live vinegar producing bacteria. It is used to start

the acetic fermentation using 7 litres of vinegar starter for each 10 litres of corrected must.

### Dry yellow corncobs

Coarsely ground corncobs are used in small quantities to speed up and increase the amount of acetic acid produced.

**Sodium bisulphate**

This is used to prevent contamination by other micro-organisms and also as a rinsing solution when washing bottles. (1 spoonful of bisulphate per litre of water)



**Citric acid and sodium bicarbonate**

Fruits have different acidity levels; some like the orange and mandarin are very acidic. Others like the banana or peach are less so. The acidity must be adjusted so that the yeast can properly grow during the alcoholic fermentation stage. Acidity is controlled by adding sodium bicarbonate to the very acid fruits and citric acid to fruit with little acid (see Recommendations for quantities to use for each fruit).

**Sugar**

Sugar is used to increase the fruit juice sugar concentration. 120 grams of sugar is used for every litre of diluted must.

**Equipment and materials**

- teaspoon
- scales
- cooker
- kerosene or firewood
- hosepipe
- wooden stirrer
- thermometer
- glasses
- measuring jugs
- chopping boards
- measuring cylinder
- 450 and 150 ml clear bottles
- alcohol fermentation & storage vats
- tubs/baths
- non resinous wooden supports
- funnels
- cotton wool
- coarse cotton cloth
- calculator
- cooking pans
- plastic tubes
- 20 litre capacity liquidiser
- 250 lt. acetic fermentation barrels

**Steps to follow**

Vinegar is obtained after two fermentation stages. In the first stage, an alcohol fermentation takes place, where sugar is changed into alcohol. This takes place in the absence of oxygen (without air). In the second stage, acetic fermentation takes place and the alcohol

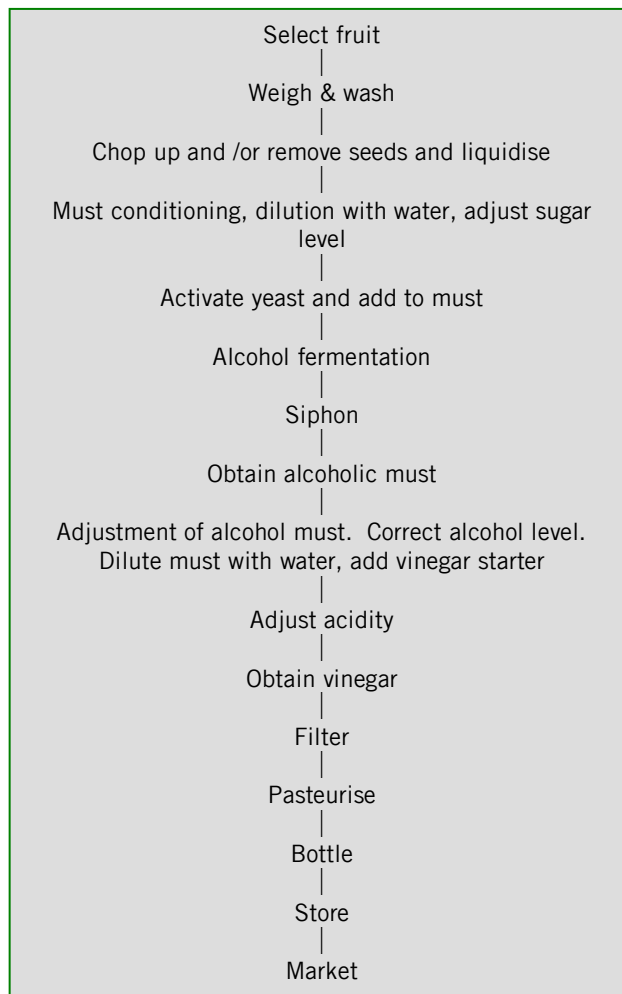

is turned into acetic acid. Here oxygen is essential. Vinegar for food use must contain between 4% and 5% acetic acid. The following page shows the main steps involved in the production of fruit vinegar.

**The production process**

The actual production takes two months. This is followed by 20 days in storage tanks.

technical brief

### Choosing and preparing raw material

Before beginning you must wash your hands and tie your hair back. You can now begin to make the ripe banana vinegar.

In this example, take 50 kg of ripe bananas.

Weigh the fruit with peel on and then peel the bananas. You should then have 33 kg of peeled banana. 150 litres of water must be boiled, preferably the day before so that it has cooled to room temperature.

### Preparing the Must

The peeled fruit is liquidised; this can also be done by hand using a masher. In either case, a little warm boiled water at about 70°C is added to stop the pulp discolouring. Next, measure the quantity obtained (65 litres in this example) and pour it into the fermentation barrels. The other necessary ingredients will be added later.



#### A. Dilution of the fruit pulp with water

For every litre of pulp obtained add 2 litres of cold boiled water (see recommendations)

Therefore: 1 litre pulp - 2 litres water  
65 litres pulp - 130 litres water

Total must volume = 65 litres (pulp) + 130 litres (water) = 195 litres of diluted must (diluted)

#### B. Sugar adjustment

After diluting the must with water, the sugar concentration has decreased. Therefore, it is necessary to add 120 gr. of sugar per litre of total of diluted must. For each litre of must 120 gr. of sugar is required. Therefore, 195 lt. of must will require 23.50 kg of sugar.

#### C. Acid correction

In the case of banana, citric acid has to be added (see recommendations).

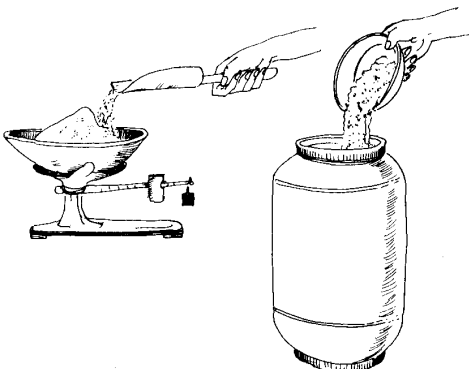

In this example, half a teaspoon of citric acid per 10 litres must is required.

**Yeast activation**

For the alcohol fermentation, we use 1 gr. of bread yeast per litre of must. So, we will need to dissolve 195 gr. of yeast in the 195 lt. of must. But first the yeast needs to be activated. Place the yeast in a glass containing warm water, must and sugar. Mix it well and leave it in a warm place (30°C) for 15 - 20 minutes. The yeast is activated when bubbles appear on the surface.

**Preparing must**

Use half a glass of water + 1 teaspoon of sodium bisulphate.

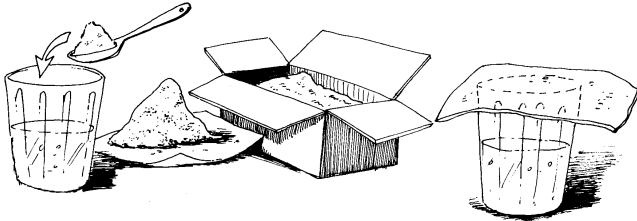

warm boiled water ~ 1 gr. yeast/lt. must ~ put in warm place

**Starting the alcoholic fermentation**

Add the activated yeast to the corrected must and stir it with the wooden stirrer. Hermetically seal the container and connect a fermentation lock in the top.

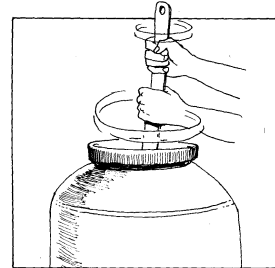

The fermentation lock consists of a cork with a hole in the centre through which passes a 5mm diameter plastic tube. This must end up in the glass, which contains a small spoonful of bisulphate in half a glass of water.

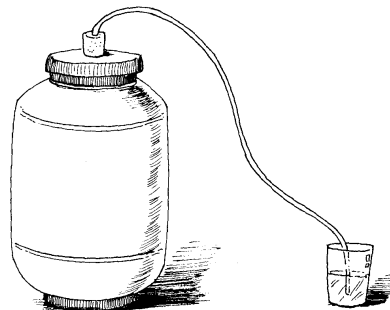

**Siphoning**



After 20 days of alcoholic fermentation, the upper portion is siphoned off to separate the yeast residue and fruit pulp at the bottom of the container. To do this we use another container covered with a piece of cloth on top of which there are two layers of cotton, as shown in the picture

The alcohol must is returned to clean containers to next be used in the acetic fermentation



technical brief

To start the acetic fermentation, the alcohol content and the acidity of the siphoned must needs to be corrected. Also, it is recommended that containers used should have plenty of free space in them to give better oxygenation during the acetic fermentation.

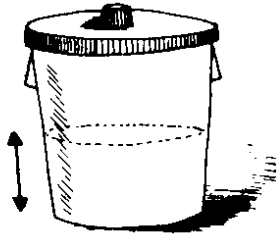

In this case we use a 250 litre container but will only fill it with 140 litres of alcoholic must.

### Preparing alcohol must

#### A. Correcting alcohol level

Once the siphoned alcoholic must is obtained we separate a quantity (20 Lt.) and dilute it with 60 Lt. of cold boiled water, i.e. 3 litres of cold boiled water per 1 litre of must. By doing this we lower the alcohol content.

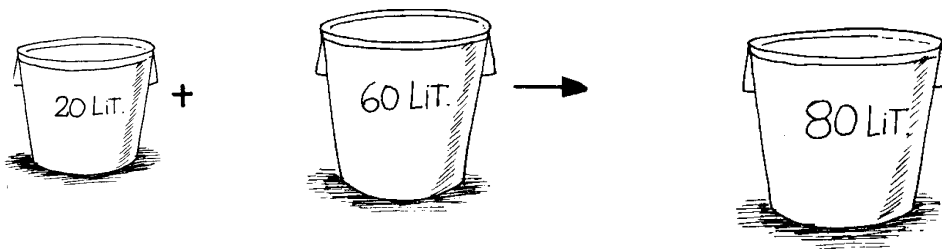

alcohol must (20lts.) + cooled boiled water (60 lit) = diluted alcohol must (80 lit)  
 14°alcohol 10°alcohol

#### B. Correcting acidity

The vinegar starter is next added to the diluted alcoholic must and the conversion of the alcohol into acetic acid. Unpasteurised vinegar (the starter) is added in the following proportions: 7 litres of starter vinegar per 10 litres of diluted alcohol must. This increases the acidity of the must.

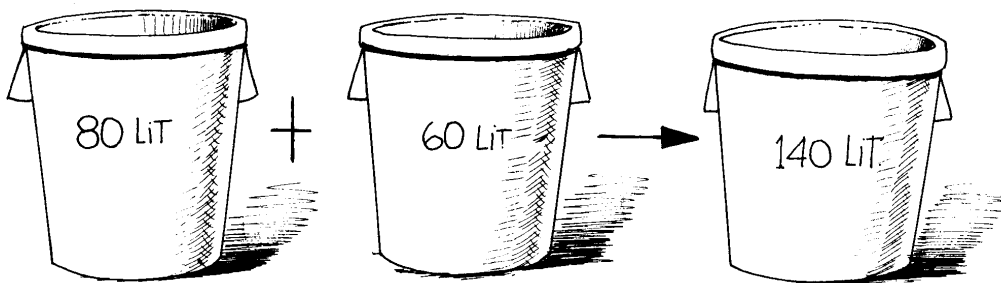

alcohol must diluted (10 degrees) (0.04% acidity) + vinegar starter (5% acidity) (0° alcohol degrees) = prepared alcohol must (3% acidity) (9 alcohol degrees)

7.0 litres of vinegar starter are needed for every 10 litres of alcohol must  
 So, for 80 litres of alcohol must 56 litres of starter vinegar should be used.

### Acetic fermentation

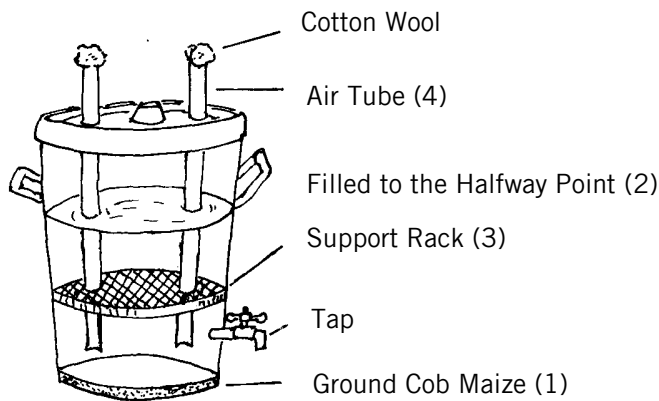

### Fermentation equipment

First, the acetic fermentation equipment must be got ready. This must have a thin layer of ground maize cobs at the bottom of the container (1). It is then filled with the prepared alcoholic must to the 160 litre mark when using a 250 litre vessel. The support grille (3) is then put in place. This grille is made from a ring of non-resinous wood with the central part covered with nylon mesh. Plastic tubes (4) pass through the cover and the support grille. These are needed to supply air to the must.

The initial acetic fermentation takes 60 days. After about 18 days, a whitish layer or skin appears on the surface or on the wooden support. From this moment the acidity begins to increase reaching approximately 5% acetic acid during the remaining days.

### Obtaining the vinegar

After the required number of days of acetic fermentation and the white layer has formed on the surface; as a thickish gelatinous skin; the vinegar reaches 5% acidity. The next steps are to:

1: Separate 20 litres of vinegar with approximately 5% acetic acidity into a container.

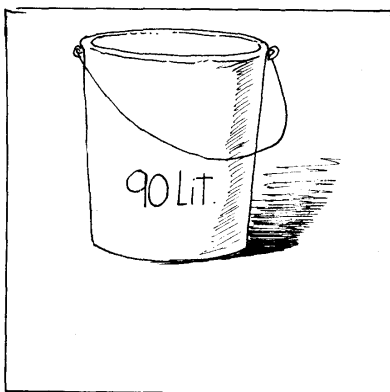

2: Add 100 litres more of prepared alcoholic must to the remaining 70 litres of vinegar.  
How do we obtain this prepared alcohol must?



technical brief

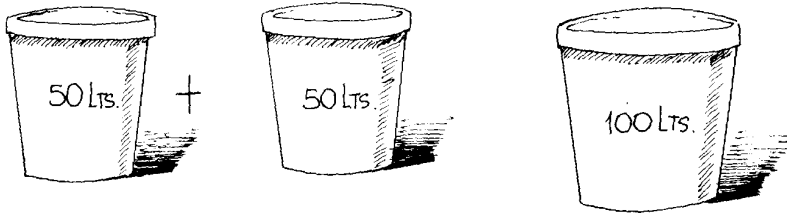

50 litres of alcoholic must + 50 litres of cooled

boiled water = 100 litres prepared alcohol must

At this stage - obtaining the vinegar and adding more prepared alcohol must is carried out every 20 days.

**Filtering**

The vinegar is filtered after being separated from the fermentation equipment. The filter is a layer of cloth with two layers of cotton wool placed over the container.

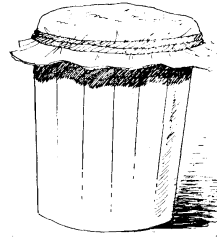

**Pasteurisation**

The filtered vinegar is heated to 80°C for 15 to 20 minutes, to avoid contamination and the development of more acid.

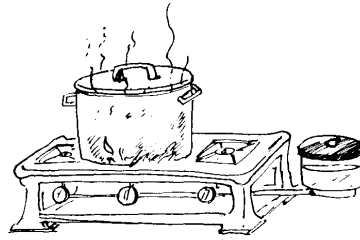

**Bottle preparation**

While the vinegar is filtering, the bottles can be selected and washed. As the bottles used are second-hand, they must be soaked in detergent and one small spoonful of caustic soda. Then, rinse with 1 small spoonful of bisulphate per 10 litres of water. Finally, stand them to drain.



**Bottling**

A clean funnel is used to fill the bottles and they are corked by hand. For better presentation, put a plastic shrink sleeve over the cork.

Use 450 or 250 ml clear bottles.

technical brief

### Marketing

We can sell our fruit vinegar in 450cc to 250 ml containers in the following ways:

- 1 Directly in the market or to family and friends.
- 2 Through shops, provided that we have obtained the required industrial and health registration for our products.



#### Recommendations

1. If using other types of fruit, the following points will need to be taken into account:

#### Dilution

(Water/fruit pulp)

Fruit	Dilution
Peach vinegar	1.5/1.0
Apple vinegar	1.5/1.0
Pineapple vinegar	1.5/1.0
Melon vinegar	3.0/1.0
Soursop vinegar	2.0/1.0

#### Acidity Correction

Peach must	1 small teaspoonful of citric acid/ 10 litres of must
Apple must	1 small teaspoonful of bicarbonate/10 litres of must
Pineapple must	1 small teaspoonful of bicarbonate/10 litres of must
Melon must	1 small teaspoonful of citric acid/10 litres of must
Soursop must	1 small teaspoonful of bicarbonate/10 litres of must

2. The vinegar can be used other products such as pickles, mustard or as a condiment.
3. The solids remaining obtained in the alcohol fermentation, after siphoning can be used in the next alcoholic fermentation.
4. The use of a specific gravity spindle gives a better control over the alcohol fermentation process.

#### Investment costs

The following equipment will be needed to produce 350 litres of vinegar a month (778 bottles of 450 mls):-

(All prices are in \$US in force on the 23rd July 1991. The rate of exchange was 1\$ dollar = 0.810 soles).



We needed 3 workers.

### A. Costs of establishing the business

Preparing the production room, licences and registration - \$46.47

### B. Cost of equipment and materials

	Price per unit (\$)	Quantity	Total Cost (Unit)	Useful Life (years)	Deprecia tion (\$)
cooker semi-industrial	185.00	1	185.00	8	23.10
pan scales	170.00	1	170.00	7	24.20
calculator	7.50	1	7.50	5	1.50
industrial liquidiser (cap. 20 lts)	1200.00	1	1200.00	10	120.00
buckets (cap. 15 lts)	1.40	3	4.20	3	1.30
plastic vats (cap. 150 lts)	25.00	2	50.00	4	12.50
knives/spoons	1.50	6	9.00	5	1.80
tubing	0.80	6	4.80	2	2.40
funnels	0.45	5	2.25	3	0.75
measuring jugs	1.20	2	240.00	4	0.61
plastic vats (250 lts)	49.00	4	196.00	4	49.00
aluminium pans (60 lts)	60.00	2	120.00	5	24.00
chopping boards	2.50	3	7.50	3	2.50
baths	3.70	2	7.40	3	2.46
tables	37.00	2	74.00	8	9.30
plastic tubes	0.60	2	1.20	2	0.60
wooden stands	12.30	2	24.60	4	6.15
fermentation locks	0.40	4	1.60	3	0.53
densimeter (0 -1.80)	15.00	2	30.00	3	10.00
thermometer (0 – 150°C)	12.00	1	12.00	3	4.00
		\$	2134.45	\$	302.95

### C. Fixed costs (per month)

	\$
Renting premises	30.78
admin materials	16.20
light, water etc.	12.15
depreciation	27.50
personnel (management, sales, purchases)	123.50
insurance, registering etc	12.00
repairs and maintenance (equipment, premises)	12.50
	<u>\$232.38</u>
Miscellaneous (10%)	23.46
Total fixed costs	<u>\$255.62</u>

### D. Variable or production costs

These are the expenses and quantities necessary to produce one 450 ml bottle of vinegar.

	expense (\$)	price per unit (\$)	total cost (\$)
Raw material(banana) (Kg)	0.1420	0.120	0.0017
Labour (day)	0.0200	1.850	0.0370
Yeast (g)	0.4500	0.004	0.0020
Sodium bisulphate (kg)	0.0001	2.500	0.0003
Vinegar starter (lts)	0.6850	0.240	0.1640
Sugar (kg)	0.0680	0.500	0.0340
Citric acid (g)	0.1000	0.003	0.0003
Bottles (450 cc)	1.0000	0.050	0.0500
Plastic tops (unit)	1.0000	0.020	0.0200
Cap sleeves	1.0000	0.030	0.0300
Labels	1.0000	0.008	0.0080
kerosene (gal)	0.0140	1.450	0.0200
cotton (pack) 500 g	0.0080	1.300	0.0100
Water (lts)	0.4280	0.220	0.0940
			\$ 0.4866
Marketing costs (10%)			0.0487
Miscellaneous (10%)			0.0535
			<b>\$ 0.5888</b>

To produce different quantities eg 778 (450 cc) bottles (or 350 litres of vinegar) we need  
 - banana 778 x 0.142 = 110 kg of banana  
 - sugar 778 x 0.068 = 52.90 Kg of sugar  
 and so on for every ingredient.

**Break even production**

Knowing the variable costs per bottle (\$ 0.59) and the sale price per bottle of vinegar (1.01) we can calculate the production quantity which will be equal to the total monthly income plus costs (break even production) i.e. one neither gains or loses money when producing this amount of vinegar.

$$\text{Break even production} = \frac{\text{Total fixed costs of vinegar}}{\text{Sale price per bottle} - \text{Variable cost per bottle}}$$

In our example:

$$\text{Break even} = \frac{\$255.62}{1.01 - 0.59} = 609 \text{ bottles of vinegar (450 ml)}$$

**Profitability of the plant**

Monthly volume of production (bottles) (450 cc)	Percentage use of capacity (%)	Total earnings of the plant (\$ US)	Total income per person/month (\$US)
609 (break even)	31	0.00	7.59
778	39	68.64	9.60
2000(max. cap.)	100	581.70	24.67

**Total Investment for Plant**

A) Setting up costs	\$	146.47
B) Costs of equipment and materials	\$	3109.45
C) Fixed costs	\$	255.62
D) Variable costs (4 weeks) + (50 kg. of fruit)	\$	465.02
	<b>Total</b>	<b>\$ 4379.58</b>

## References and further reading

- [Fermented Fruits and Vegetables: A Global Perspective](#), FAO, 1998
- [Vino de Frutas: Serie Procesamiento de Alimentos 6](#), ITDG Latin America, 1998
- [Fruit Processing](#), a selection of Practical Action Technical Briefs
- [Fruit Waste Utilisation](#), Practical Action Technical Brief
- [Juices and Drinks](#), a selection of Practical Action Technical Briefs
- [Principles and practices of small and medium-scale fruit juice processing](#). FAO Agricultural Services Bulletin 146, Food and Agriculture Organization of the United Nations (FAO), (2001).
- [Technical manual on small-scale processing of fruits and vegetables](#), Food and Agriculture Organization of the United Nations (FAO)
- [Setting up and Running a Small Fruit or Vegetable Processing Enterprise: Opportunities in Food Processing](#) CTA
- [Starting a Small Food Processing Enterprise](#) by Peter Fellows, Ernesto Franco & Walter Rios Practical Action Publishing/CTA 1996
- [Small Scale Food Processing](#) 2<sup>nd</sup> Ed. P Fellows & S Azam Ali, Practical Action Publishing, 2003
- [Fruit and Vegetable Processing](#) UNIFEM Practical Action Publishing, 1993

This document has been translated from *Vinagre de Fruta: Serie Procesamiento de Alimentos 2*, Diana Colquichagua and illustrations by César Ayllón, ITDG Latin America, 1992, ISBN 1 85339 0461.

Soluciones Prácticas - Practical Action Latin America  
 Casilla Postal 18-0620  
 Lima 18  
 Perú  
 Tel: +51 1 4467324/4447055  
 Fax: +51 1 4466621  
 E-mail: [info@solucionespracticas.org.pe](mailto:info@solucionespracticas.org.pe)  
 Website: <http://www.solucionespracticas.org.pe/>

Practical Action  
 The Schumacher Centre  
 Bourton-on-Dunsmore  
 Rugby, Warwickshire, CV23 9QZ  
 United Kingdom  
 Tel: +44 (0)1926 634400  
 Fax: +44 (0)1926 634401  
 E-mail: [inforsew@practicalaction.org.uk](mailto:inforsew@practicalaction.org.uk)  
 Website: <http://practicalaction.org/practicalanswers/>

Practical Action is a development charity with a difference. We know the simplest ideas can have the most profound, life-changing effect on poor people across the world. For over 40 years, we have been working closely with some of the world's poorest people - using simple technology to fight poverty and transform their lives for the better. We currently work in 15 countries in Africa, South Asia and Latin America.